

Reference

**CSA7000 Series
Communications Signal Analyzers**

**TDS7000 Series
Digital Phosphor Oscilloscopes**

071-7000-01



071700001

To Use the Front Panel

You can use the dedicated, front-panel knobs and buttons to do the most commonly performed operations.

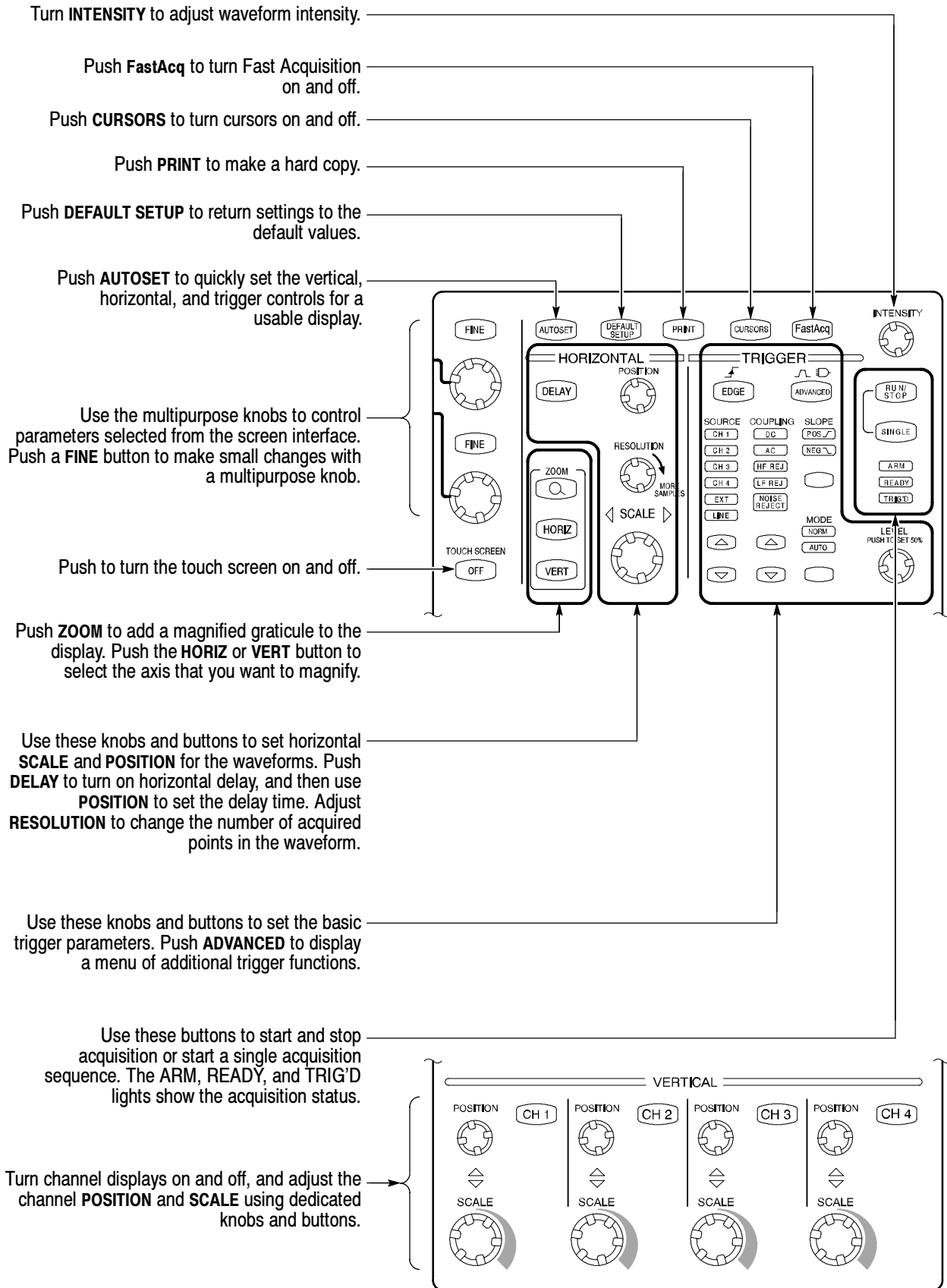

To Use the Screen Interface

You can control all oscilloscope functions except the power switch using only the screen interface.

Choose the Toolbar

Touch a button in the toolbar to display a control window at the bottom of the display.

Touch a screen control to change a setting.

Touch a numerical control to assign that control to a multipurpose knob. Turn the multipurpose knob to adjust the parameter value.

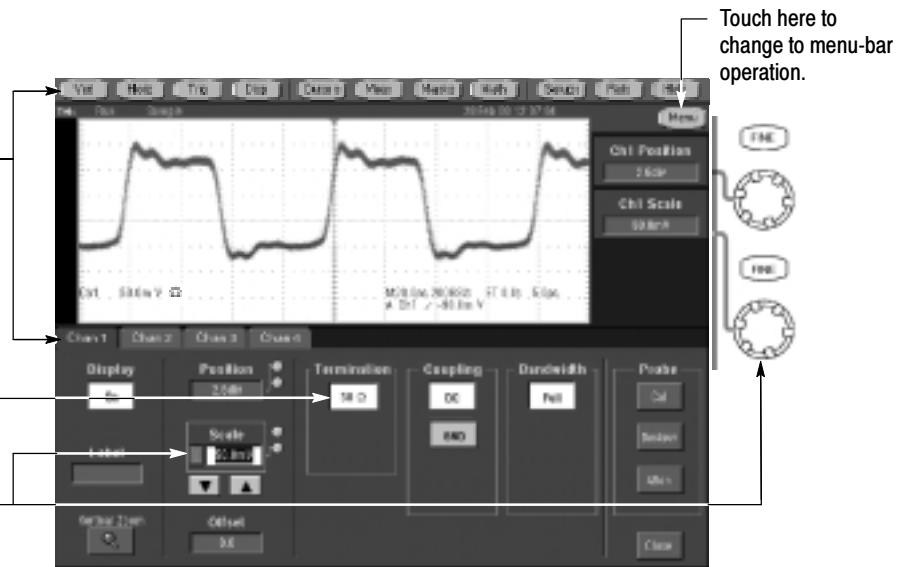

Or Choose the Menu Bar

Use some menu items to display a control window at the bottom or side of the display.

Use some menu items to directly change settings.

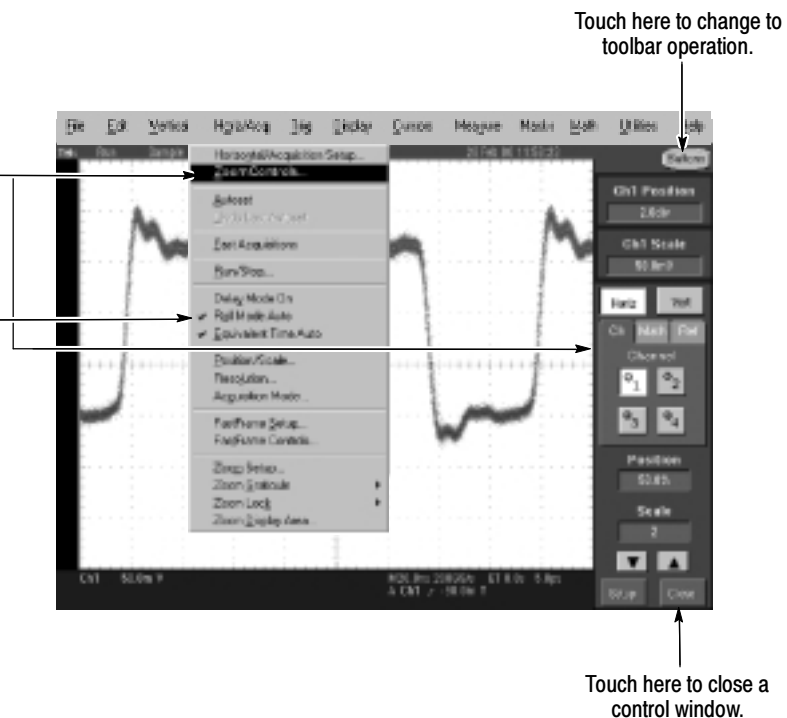

More Operating Tips:

- Use the touch screen to control the oscilloscope when bench space is unavailable, such as on a cart or in an equipment rack.
- Plug in a mouse and keyboard if you have the bench space to use them. You can plug in a USB mouse or keyboard anytime, even while the oscilloscope is running.
- Use the menu bar to access PC-related functions, such as Page Setup, Export, and Copy.

To Display a Waveform

Attach a probe to CH 1 and connect the probe to your signal. **1**

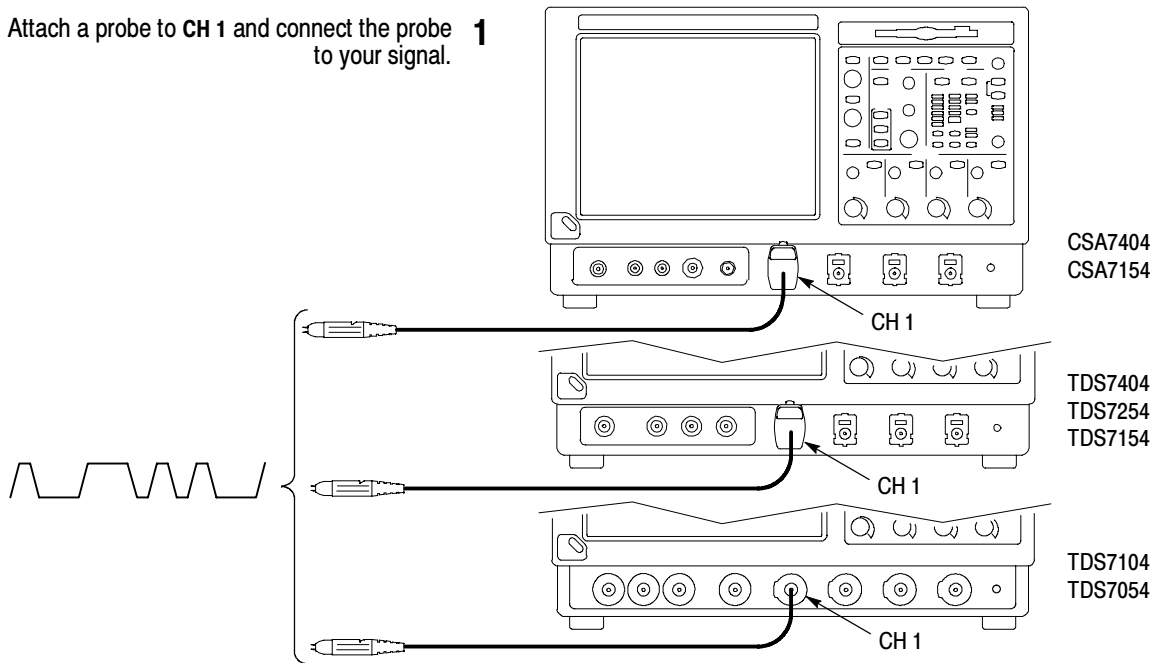

Push **CH 1** if channel 1 is not already displayed. **2**

Push **AUTOSET**. **3**

Adjust **VERTICAL** and **HORIZONTAL** POSITION and **SCALE** if necessary to optimize the display. **4**

Adjust **RESOLUTION** to change the record length and sample rate. You can acquire more samples in the waveform to see more detail or acquire fewer samples with a faster update rate. **5**

Adjust **INTENSITY** to change the brightness, vector fill, and display persistence of acquired points. **6**

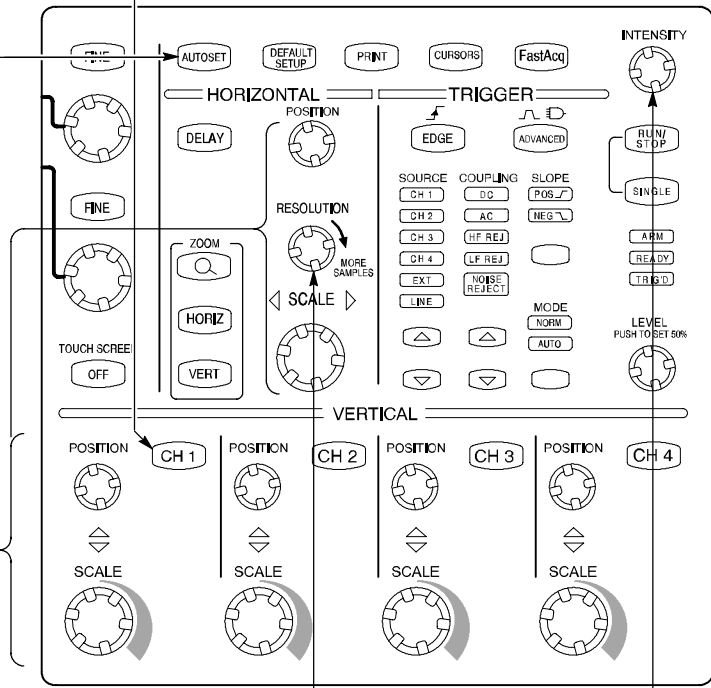

To See More Waveform Detail

Use Zoom

Use the Zoom function to magnify an acquisition vertically, horizontally, or in both display dimensions. **POSITION** or **FACTOR** changes that you make to the Zoom graticule affect only the zoom display, not the actual acquired waveform.

1 Push the **ZOOM** button to display a zoom graticule.

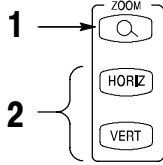

2 Push the **HORIZ** button or the **VERT** button to select the axis you want to magnify in the zoom graticule. Use the multipurpose knobs to adjust the zoomed waveform's position and magnification factor.

3 You can also set up a zoom graticule from the screen interface. First touch and drag across the segment of the waveform that you want to see in greater detail.

4 Then select a zoom graticule mode from the drop-down list to magnify the highlighted waveform segment.

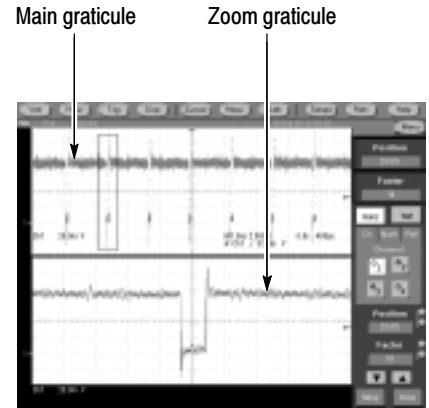

Use Horizontal Delay

Use horizontal **DELAY** to acquire waveform detail in a region that is separated from the trigger location by a significant interval of time.

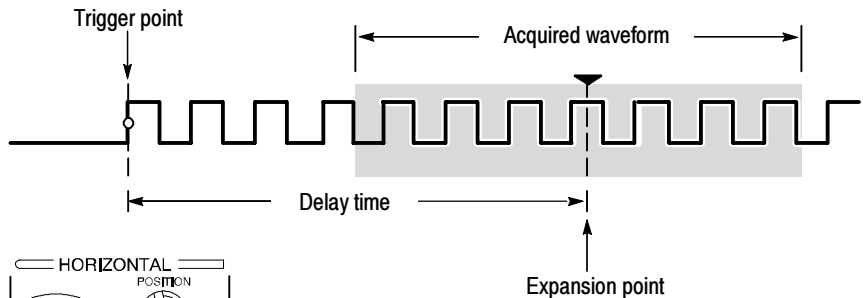

1 Push the front-panel **DELAY** button.

2 Adjust the delay time with the horizontal **POSITION** control, or enter the delay time in the control window.

3 Adjust the horizontal **SCALE** to acquire the detail you need around the delay expansion point.

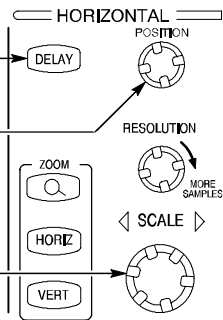

More Operating Tips:

- You can use Zoom and Horizontal Delay together to magnify a delayed acquisition.
- Toggle Horizontal Delay on and off to quickly compare signal details at two different areas of interest, one near the trigger location and the other centered at the delay time.

To Use Fast Acquisition

Turn Fast Acquisition on to acquire up to 400,000 waveforms per second.

1 Push the front-panel **FastAcq** button.

Or select **Fast Acquisitions** in the **Horiz/Acq** menu.

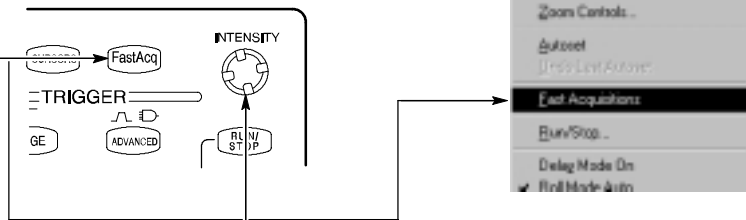

2 Adjust **INTENSITY** to optimize the intensity or color grading for the signal you want to analyze. Increasing intensity can make less-frequently acquired points brighter in the display.

How DPOs Work

Unlike DSOs that have long dead times between acquisitions, Digital Phosphor Oscilloscopes (DPOs) continuously acquire waveforms at rates comparable to analog oscilloscopes. In Fast Acquisition mode, DPOs continuously overlay the acquired information into a three-dimensional database that is updated on the display 30 times per second. For each pixel in the display, the intensity (or color) of the pixel is proportional to the number of actual samples that the pixel represents.

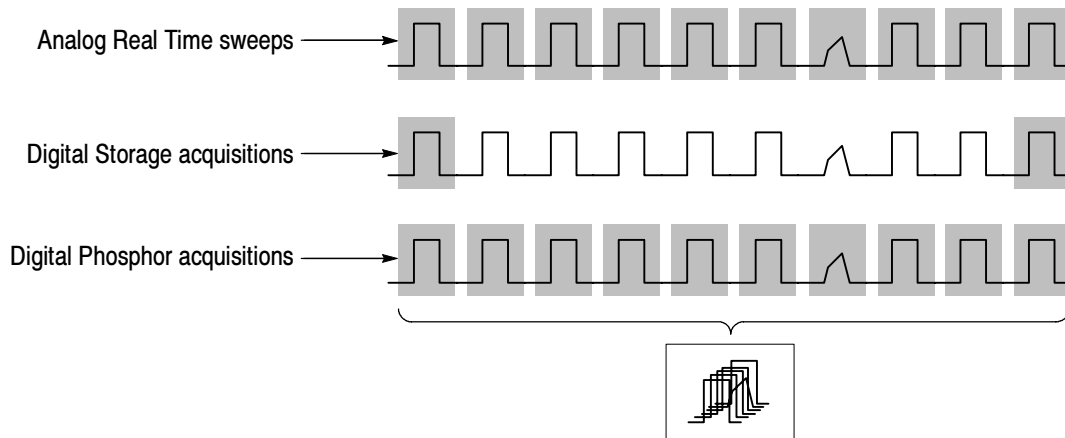
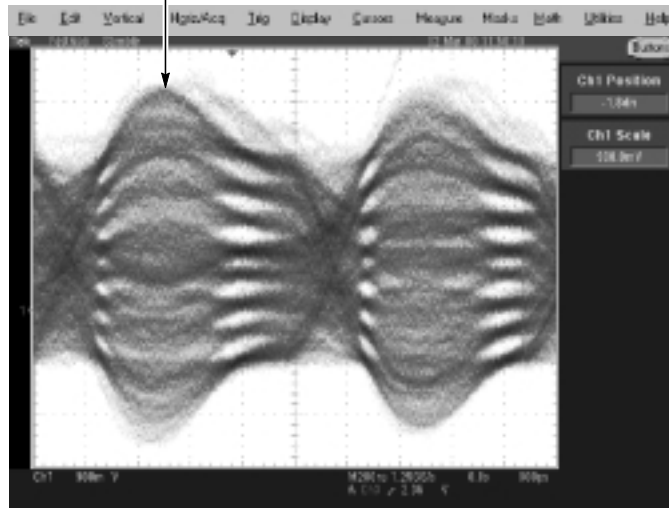

More Operating Tips:

- Choose one of the color grading palettes in the Display Colors control window to see different sample densities represented in different colors.
- Turn **AutoBright** on in the Display Appearance control window. When you use AutoBright, the displayed waveforms remain visible even at low trigger repetition rates.

To Choose an Acquisition Mode

1 Select **Acquisition Mode...** in the **Horiz/Acq** menu.
Or touch the **Horiz** button, and then select an acquisition mode in the horizontal/acquisition control window.

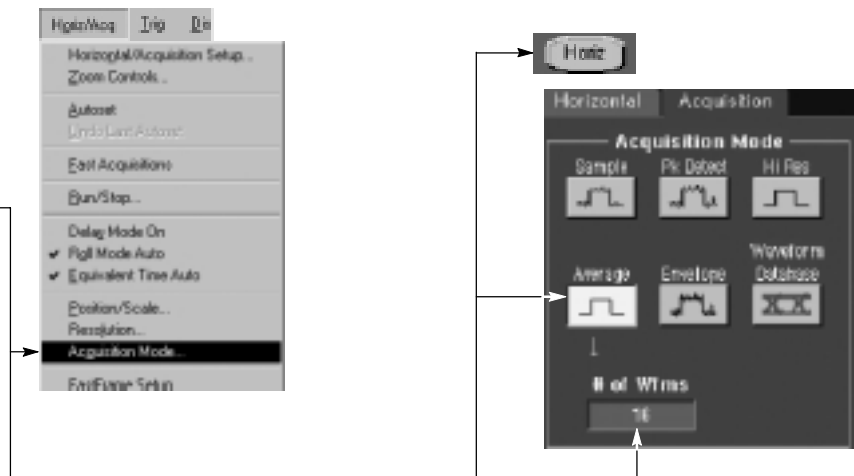

2 For Average or Envelope acquisition modes, touch the **# of Wfms** control and then set the number of waveforms with the multipurpose knob. You can also double-touch the control and use the pop-up keypad.

How the Acquisition Modes Work

$$\text{acquisition interval} = \frac{\text{record duration}}{\text{number of points in record}}$$

Displayed record points (at maximum horizontal magnification)

Sample mode retains one sampled point from each acquisition interval.

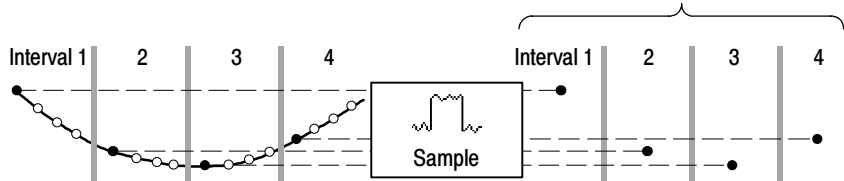

Waveform Data Base mode takes an ensemble of acquisitions that is best for accurate eye pattern measurements.

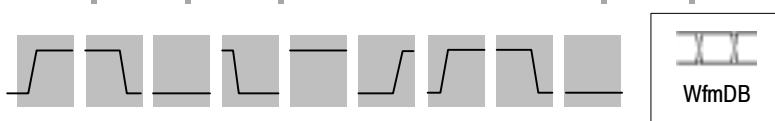

Peak Detect mode uses the highest and lowest of all the samples contained in two consecutive acquisition intervals.

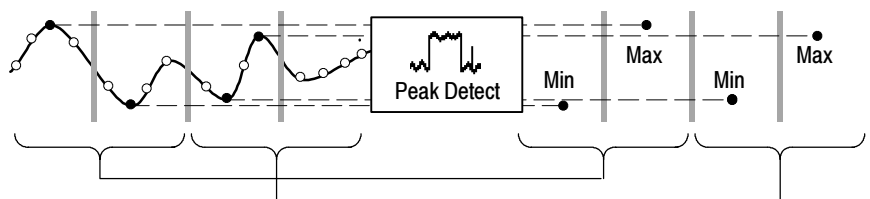

Hi Res mode calculates the average of all the samples for each acquisition interval.

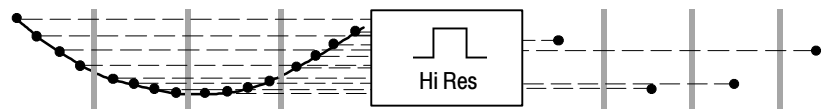

Three acquisitions from one source

Envelope mode finds highest and lowest record points over many acquisitions. Envelope uses Peak Detect for each individual acquisition.

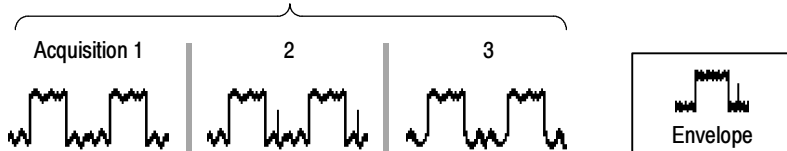

Average mode calculates the average value for each record point over many acquisitions. Average uses Sample mode for each individual acquisition.

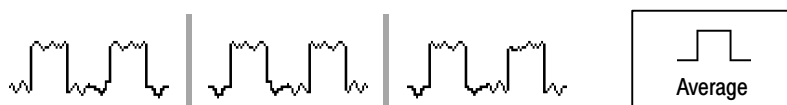

To Select a Trigger

Select the **EDGE** trigger type and then set the source, coupling, slope and mode with these front-panel controls. Push **ADVANCED** to select one of the other trigger types.

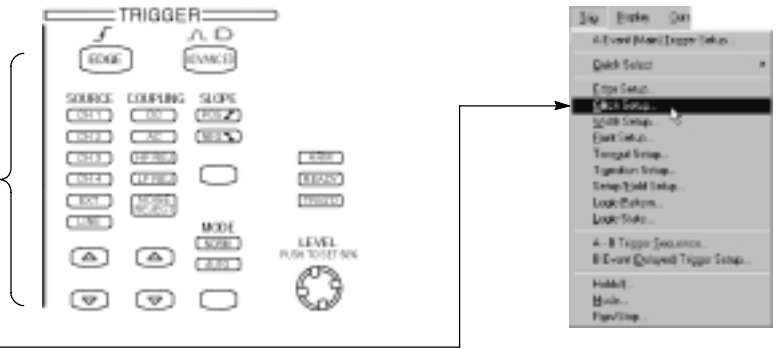











You can also select a trigger type in the **Trigger** menu.

Or touch the **Trig** button and then select a trigger type in the trigger control window that is displayed.



Trigger Selections

Trigger type	Levels	Timers	Trigger conditions
Edge 	Single level	None	Trigger on rising or falling edge, as defined by slope control. Coupling choices are DC, AC, AC LF Reject, AC HF Reject, and Noise Reject.
Comm 	Depends on Coding	None	Trigger on telecom signals. Optional on TDS7000 series.
Serial 	Single level plus clock and bit pattern	None	Trigger on serial pattern data. Optional on TDS7000 series (not available on TDS7104 or TDS7054).
Glitch 	Single level	One to specify glitch width	Trigger on glitches narrower than the specified width or ignore glitches narrower than the specified width.
Width 	Single level	Two to specify minimum and maximum pulse widths	Trigger on pulses that have widths between the range of the two timers or outside the range of the two timers.
Runt 	Two levels to define the logic transition region	One to specify an optional minimum runt-pulse duration	Trigger on a pulse that enters the transition region from one side but does not leave the region from the other side.
Timeout 	Single level	One to specify time-out time	Trigger when a signal does not make a transition for a specified length of time.
Transition 	Two levels to define the logic transition region	One to specify transition time	Trigger when a logic signal spends more time or less time in the transition region than a specified amount of time.
Setup/Hold 	Independent levels for Data and Clock	One to specify setup time and one to specify hold time	Trigger on violations of setup or hold time between a Data signal and a Clock signal. The specified setup and hold times can be positive or negative values.
Pattern 	Independent levels for each channel	One to specify pattern duration	Trigger when a Boolean combination of up to four channels becomes true. Trigger immediately or only after the combination is true for a specified time duration.
State 	Independent levels for each channel	None	Trigger on transition of one channel when a Boolean combination of up to three other channels is true.

To Use the A (Main) and B (Delayed) Triggers

You can use the A Event (Main) trigger alone or combine it with the B Event (Delayed) trigger to capture more complex signals.

1 Set the A trigger type and source in the A Event (Main) tab of the trigger control window.



2 Choose a function in the A→B Sequence tab of the trigger control window.

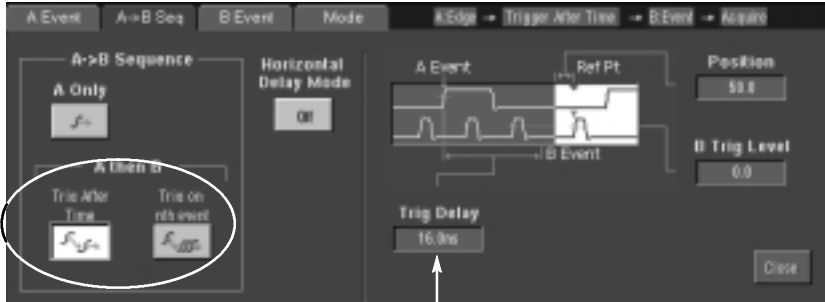

3 Set the trigger delay time or the number of B events, as appropriate.

4 Set the B trigger characteristics in the B Event (Delayed) tab of the trigger control window.



Trigger on B Event

The A trigger arms the oscilloscope. Posttrigger acquisition starts on nth B event.

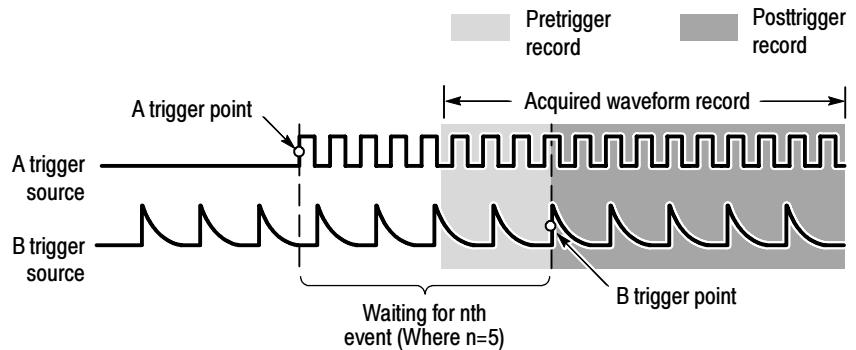

B Trigger After Delay Time

The A trigger arms the oscilloscope. Posttrigger acquisition starts on the first B edge after the trigger delay time.

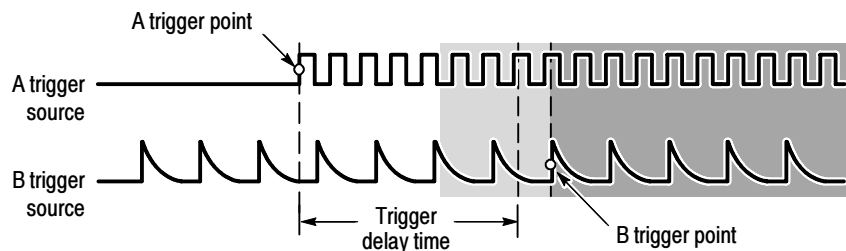

More Operating Tips:

- B-trigger delay time and horizontal delay time are independent functions. When you establish a trigger condition using either the A trigger alone or the A and B triggers together, you can also use horizontal delay to delay the acquisition by an additional amount.
- When using the B trigger, the A trigger can be any of the following types: Edge, Glitch, Width, or Timeout. The B trigger type is always Edge type.

To Perform Mask Testing

(standard on CSA7000, optional on TDS7000 series)

Select Mask Setup in the mask menu. **1**

Choose a mask type. **2**

Choose a mask standard. **3**

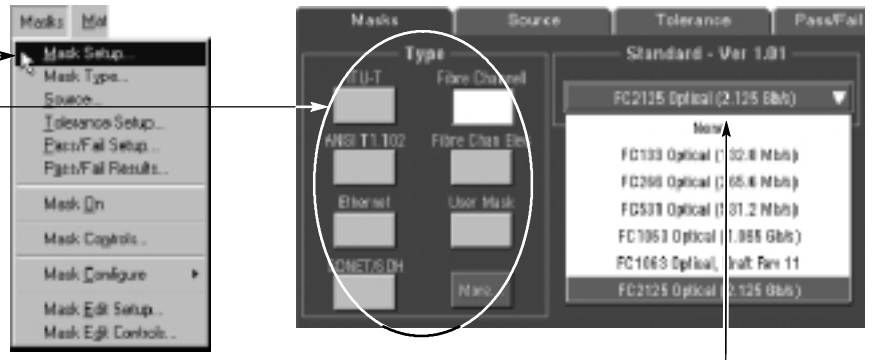

Select Autoset to automatically set up the controls based on the input signal. **4**

Optionally select Autofit to align each acquired signal with the mask to minimize the number of hits. **5**

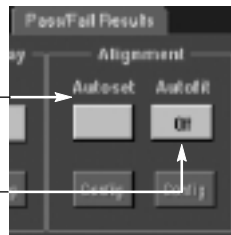

Use the Source tab to select the source of your signal.



Use the Tolerance tab to increase or decrease the mask margin used in mask testing.

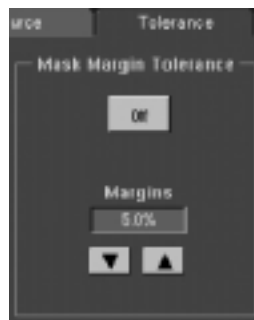

To Setup Mask Pass/Fail Testing and View Results

(standard on CSA7000, optional on TDS7000 series)

Use the Pass/Fail Setup tab to setup Pass/Fail testing. **1**

Use the Pass/Fail controls to start, stop, or continuously run a mask test. **2**

Use the Polarity controls to select testing the positive, negative, or both the positive and negative pulses. **3**

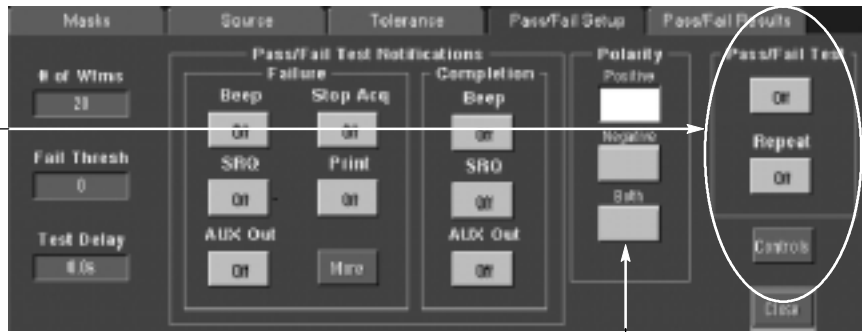

Enter the number of waveforms to acquire and use in your mask test. **4**

When using masks that enable the Waveform Database mode, the # of Wfms field changes to # of Samples field.

Enter the number of waveforms that must fail to consider the test a failure. **5**

Enter the time that the instrument delays before starting the mask test. **6**



Use the Pass/Fail Test Notification controls to select how you want to be notified when a failure occurs and when the mask test completes.



Use the Pass/Fail Results tab to view the results of your mask testing.



To Take Automated Measurements

Touch the **Meas** button, and then select up to eight measurements using the measurement control window.

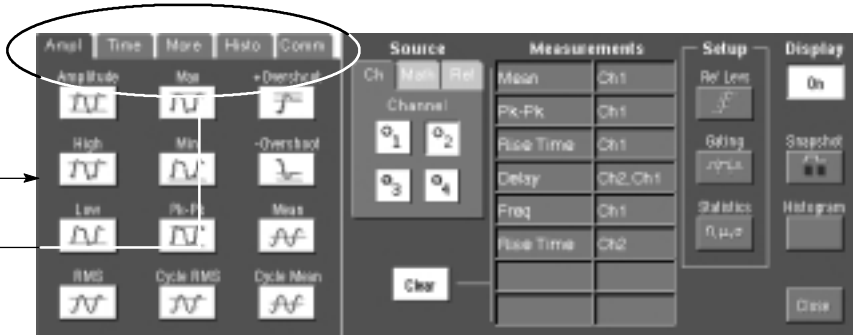

Use the tabs to access measurements by category.

Or choose a measurement for the selected waveform directly in the **Measure** menu.

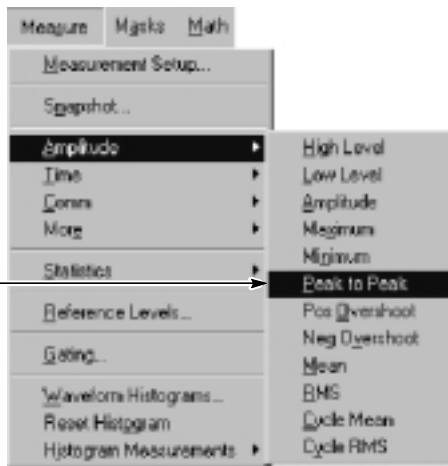

Automated Measurement Selections

Amplitude		Time		More	Histogram		Comm (optional on TDS7000 series)		
Amplitude	Max	Rise Time	Positive Width	Area	Wfm Count	Max	ExtRatio	Eye Height	Eye Top
High	Min	Fall Time	Negative Width	Cycle Area	Hits in Box	Min	Ext Ratio %	Eye Width	Eye Base
Low	Pk-Pk	Positive Duty Cycle	Negative Duty Cycle	Phase	Peak Hits	Pk-Pk	Ext Ratio (dB)	Crossing %	
RMS	Cycle RMS	Period	Delay	Burst Width	Median	Mean	Jitter P-P	Noise P-P	Cyc Distortion
Positive Overshoot	Mean	Frequency			Std Deviation	$\mu \pm 2\sigma$	Jitter RMS	Noise RMS	Q-Factor
Negative Overshoot	Cycle Mean				$\mu \pm 1\sigma$	$\mu \pm 3\sigma$	Jitter 6σ	S/N Ratio	

To Customize an Automated Measurement

Use Gating to confine the measurement to a certain portion of the waveform.

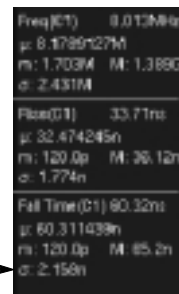
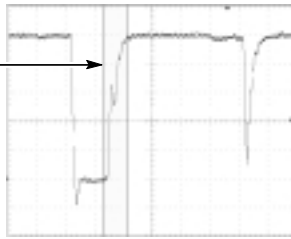

Turn on measurement statistics to characterize the stability of the measurement.

Adjust the measurement reference levels to different relative or different fixed values.

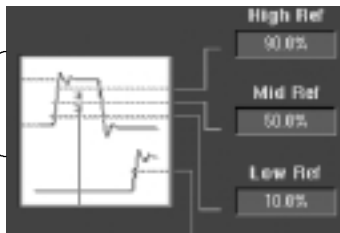

Select snapshot to see a one-time view of all valid Normal or Comm measurements.

To Set Up a Histogram

1 Touch and drag across the segment of the waveform that you want the histogram to cover. To set up a horizontal histogram, for example, make the box wider than it is tall.

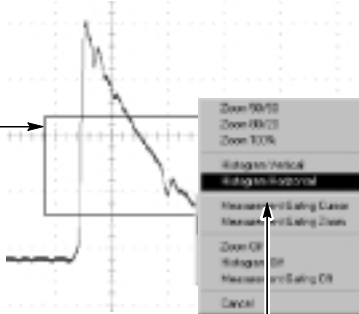

2 Select **Histogram Horizontal** from the drop-down list.

3 View the histogram at the top or edge of the graticule.

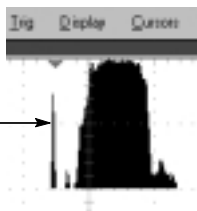

4 If you need to make any adjustments to the histogram, use the histogram setup control window.



5 Take automated measurements on histogram data. See previous page for information.

To Take Measurements With Cursors

Push the front-panel **CURSORS** button. **1** → 

Select the waveform you want to measure and a cursor type in the cursor control window.
Or you can activate cursors on the selected waveform directly in the **Cursor** menu.

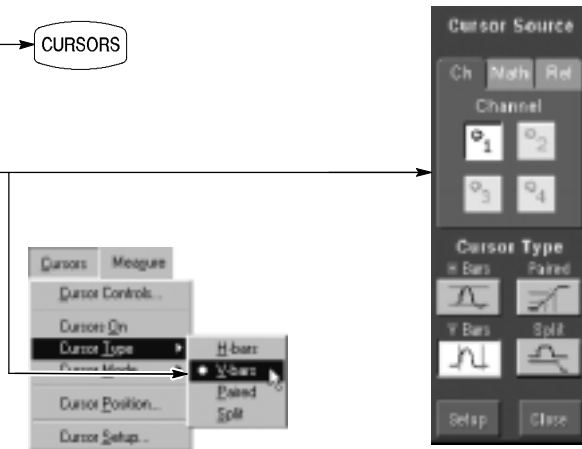

Place cursors with the multipurpose knobs or enter the cursor locations numerically. **3** →

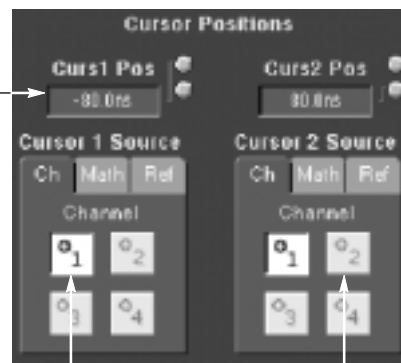

If you choose split cursors to take measurements between waveforms, select the source for each cursor. **4** →

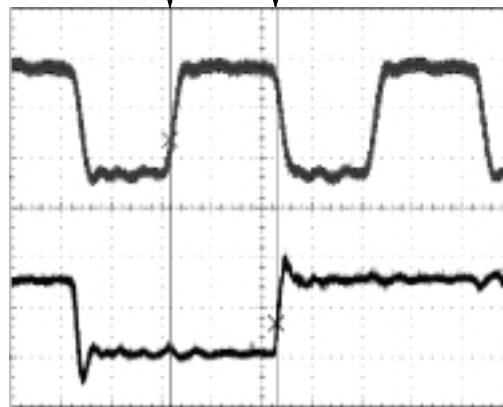

T1: 356.4 ms
T2: 352.5 ms
 ΔT : 3.92 ms
1/ ΔT : 255 Hz
V1: 5.120 V
V2: 4.886 V
 ΔV : 234 mV
 $\Delta V/\Delta T$: 59.7 V/s

Read cursor measurement results in the display. **5** →

Other Cursor Measurement Tips:

- You can set the cursors to move together in tandem if you choose the Tracking cursor mode. The cursors move independently if you choose the Independent cursor mode.
- If you use the zoom graticule, you can place a cursor directly on a specific waveform point to take precision measurements.
- You can also move cursors by touching or clicking them and then dragging them to a new position.

To Use Math Waveforms

Select **Math Setup** in the **Math** menu. **1**

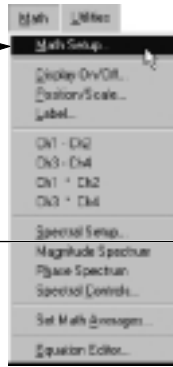

Choose one of the predefined math equations. **2**

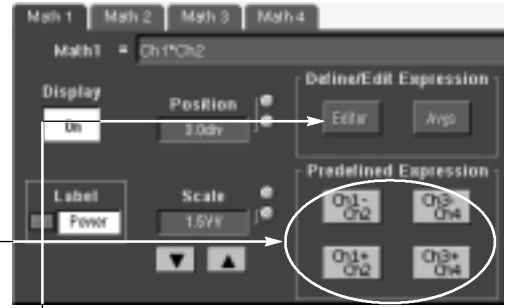

Or touch **Editor** to define a more advanced math waveform. Then build the waveform expression using sources, operators, constants, measurements, and functions.

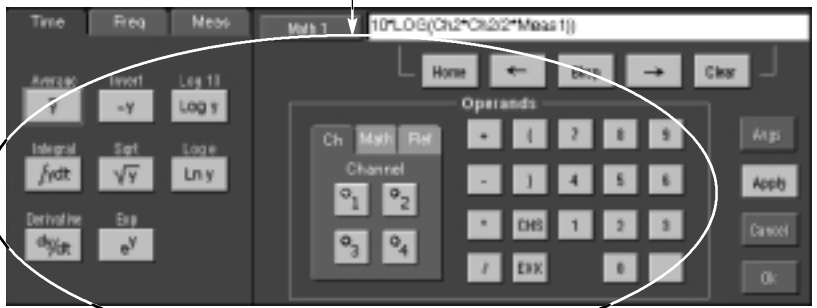

To Use Spectral Analysis

Choose **Spectral Analysis** to define FFT magnitude and phase waveforms. When an FFT waveform is selected, you can use the multipurpose knobs to adjust the FFT waveform just as you would using a spectrum analyzer.

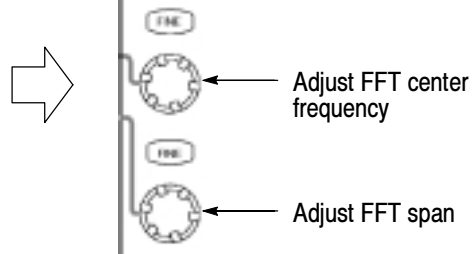

You can view time-domain and frequency-domain waveforms simultaneously. You can also use gating to select only a portion of the time-domain waveform for spectral analysis.

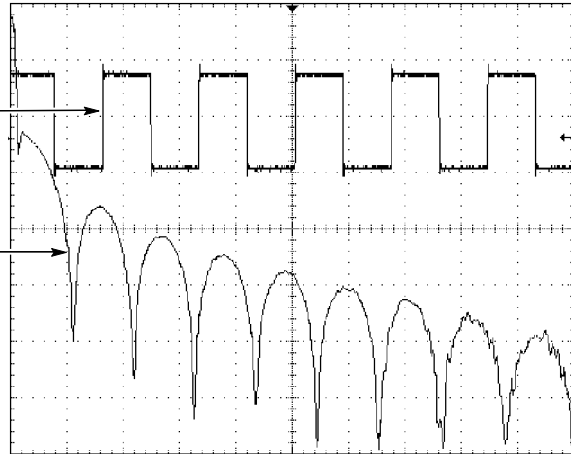

To Store Information

To Save and Recall Waveforms

To save or recall waveforms, select **Reference Waveforms** and then **Save Wfm...** or **Recall Wfm...** in the File menu.

Or touch the **Refs** button.

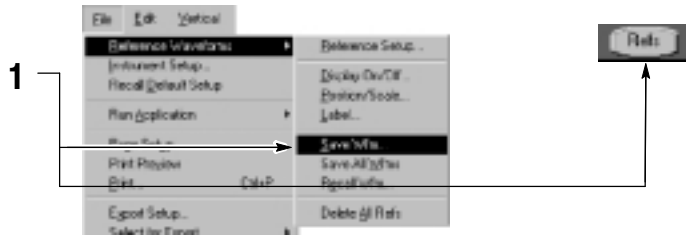

Use the reference setup control window to copy a live waveform into one of four nonvolatile reference waveform storage locations. You can also display these waveforms as reference waveforms.



Select **Save Wfm to File** to store the live waveform as a file on a disk drive. You can recall a waveform stored on disk into one of the internal reference waveform locations for display.

To Save and Recall Instrument Setups

To save an instrument setup, select **Instrument Setup** in the File menu.

Or touch the **Setup** button.



Use the settings control window to save the current setup into one of ten internal storage locations. Use the pop-up keyboard to label the setups for easy identification.

Or select **Save Settings to File** to store the current setup on a disk drive. You can recall any setup stored on disk and then save it in an internal setup storage location for quicker access.



To restore the oscilloscope to a known initial state, push the front-panel **DEFAULT SETUP** button.

Or select **Recall Default Setup** in the File menu.

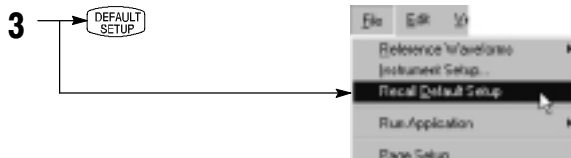

To Print a Hard Copy

To print a hard copy to an attached printer or a network printer, push the front-panel **PRINT** button.

Or select **Print** in the **File** menu. If necessary, you can make changes to the page orientation in the Page Setup dialog box.

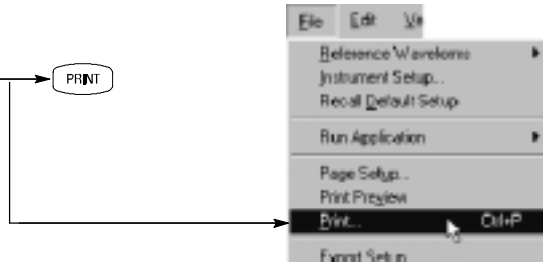

The Page Setup dialog box also includes selectors for the print palette and a feature called Ink Saver. Ink Saver optimizes the display colors and shades for printing hard copies on white paper.



To Copy or Export Your Results

You can use the Windows clipboard to copy information. Simply select the item to copy, copy it, and then paste it into another Windows application.

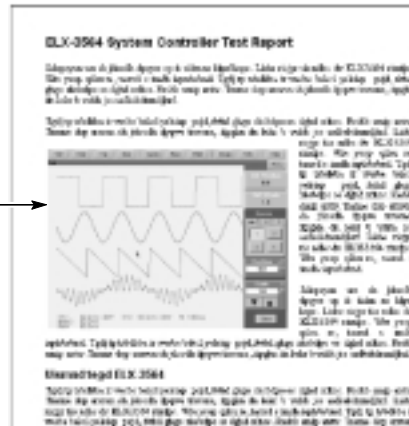

You can export waveform data into a comma-separated ACSII file for use in a spreadsheet or data analysis program. Select **Export Setup** in the **File** menu to set the output content and format for images, waveforms, or measurements.

```
-1420379613, -1400249222, -1407839845, -1415300200,
-1422629596, -1429827356, -1436892813, -1443825313,
-1479636700, -1457288891, -1463818722, -1529021630,
-1520765593, -1541896902, -1488577715, -1494424516,
-1500133037, -1505702749, -1511333139, -1516423702,
-1521573950, -1526583406, -1531451606, -1536178099,
-1540762450, -1545204233, -1549503037, -1553658465,
-1557670132, -1561537666, -1565260711, -1568838922,
-1572271966, -1575559528, -1578701302, -1581694998,
-1584546339, -1587249060, -1589804913, -1592213660,
-1594475079, -1612554849, -1598555107, -1600373340,
-1607744499, -1617739016, -1604449927, -1606169598
```

To Run Application Software

You can install and run optional application software on your oscilloscope. These software packages provide advanced capability supporting many applications. Two examples are shown below; additional packages may be available. Contact your Tektronix representative for more information.

Use **TDSJIT Jitter Analysis Software** to characterize timing performance. Analyze jitter on contiguous clock cycles using single-shot acquisitions.

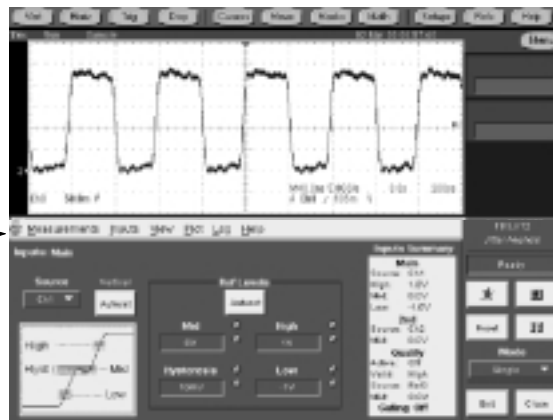

Use **TSDDDM Disk Drive Measurement Software** to measure disk drive signals according to IDEMA standards.

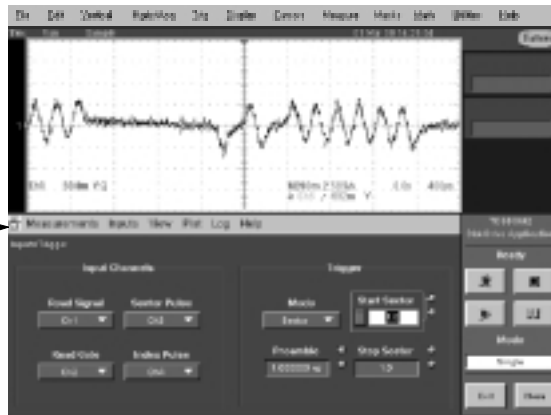

Follow the instructions provided with the application software to install it. To run the software, select the application in the **File / Run Application** menu.



To Connect to a Network

Like any other Windows computer, you can connect the oscilloscope to a network to enable printing, file sharing, internet access, and other communications functions.

To make a network connection, consult with your network administrator, and then use the standard Windows utilities to configure the oscilloscope for compatibility with your network.

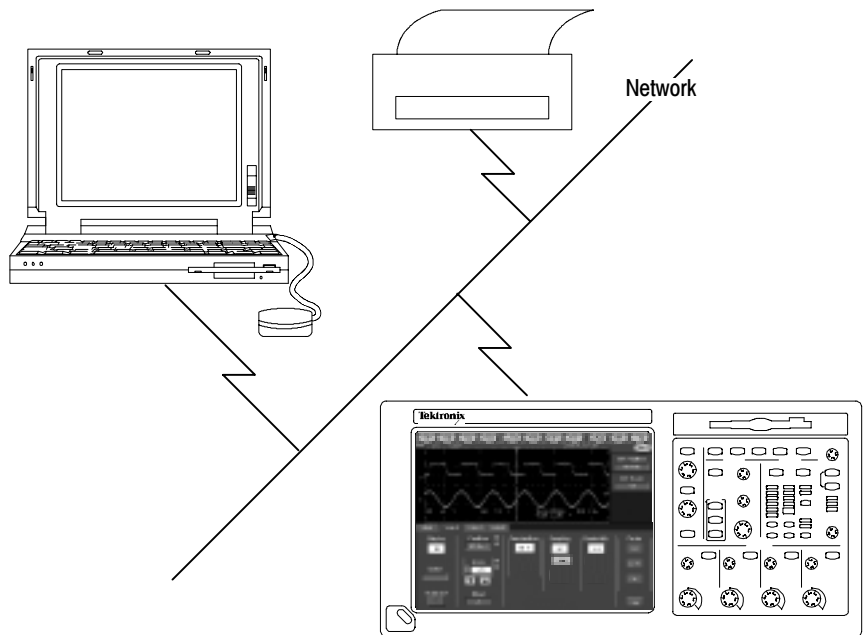

To Use a Dual Monitor

Connect a keyboard, mouse, and monitor to the oscilloscope and configure Windows for dual-monitor mode. You can operate the oscilloscope while having full use of Windows and other installed applications on the external monitor.

Connect the monitor to the upper SVGA port on the oscilloscope rear panel. Use the Settings tab in the Windows Display Properties dialog box to set up a dual-monitor configuration.

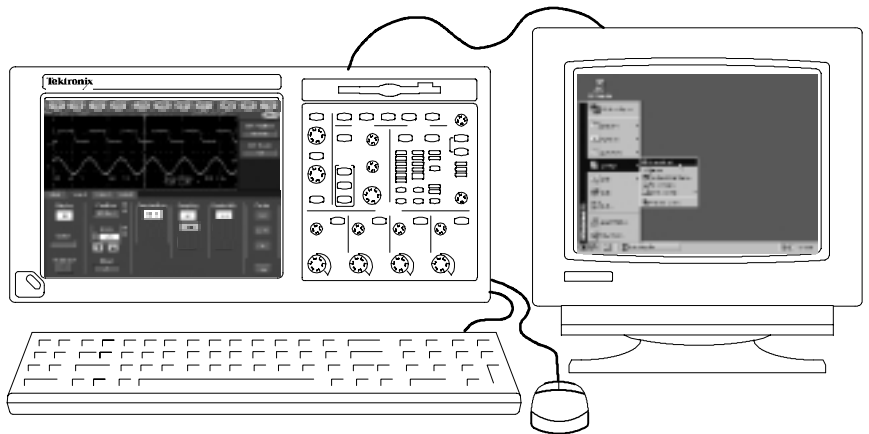

To Access the Help System

Touch the **HELP** button or select **Help on Window** in the **Help** menu to receive context-sensitive help on the current setup.

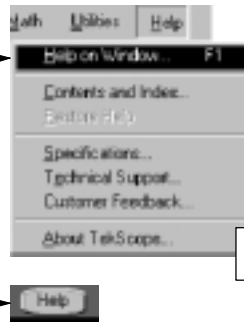

Select **Contents and Index** in the **Help** menu to access any topic in the help system. Select the topic, and then touch the **Display** button in the dialog box.



Touch an outlined control shown in the help window to receive more specific information about the control.



Touch a tab in a help window to navigate between the Overview and specific topics.

Touch the **Minimize** button in a help window to move help out of the way so you can operate the oscilloscope. Touch the **Restore Help** button to see the last help topic again.



Front Panel Inputs and Outputs

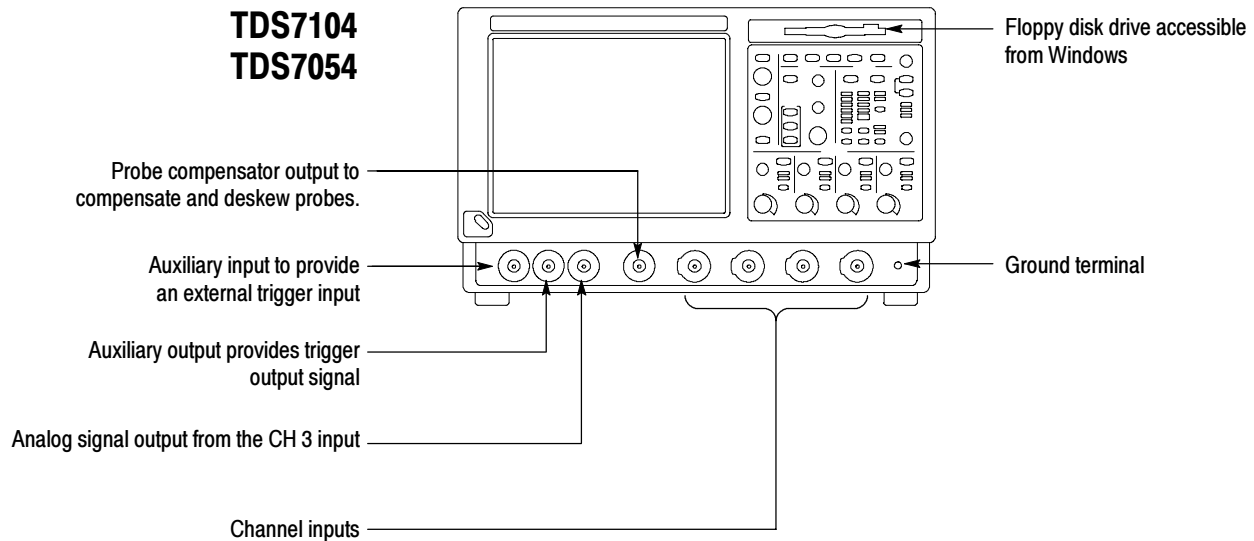
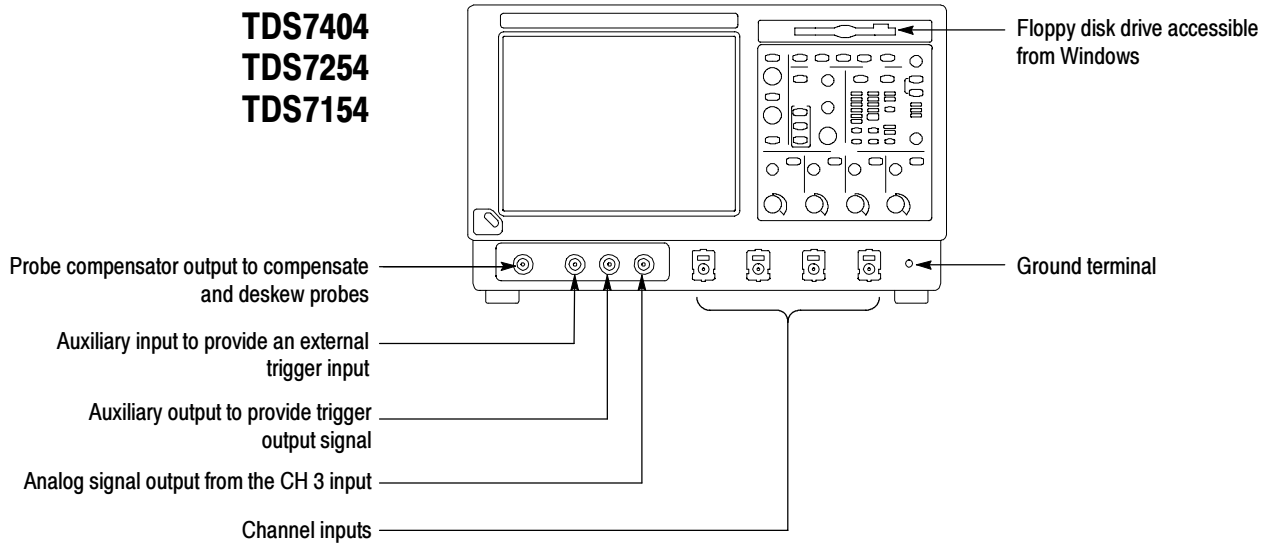
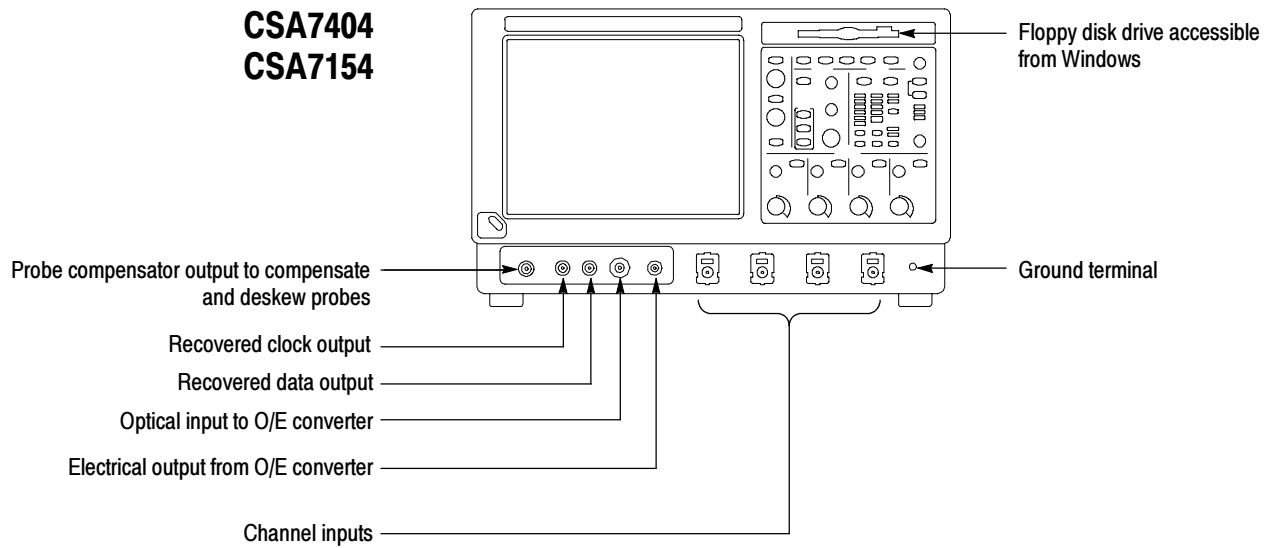

Rear Panel Inputs and Outputs

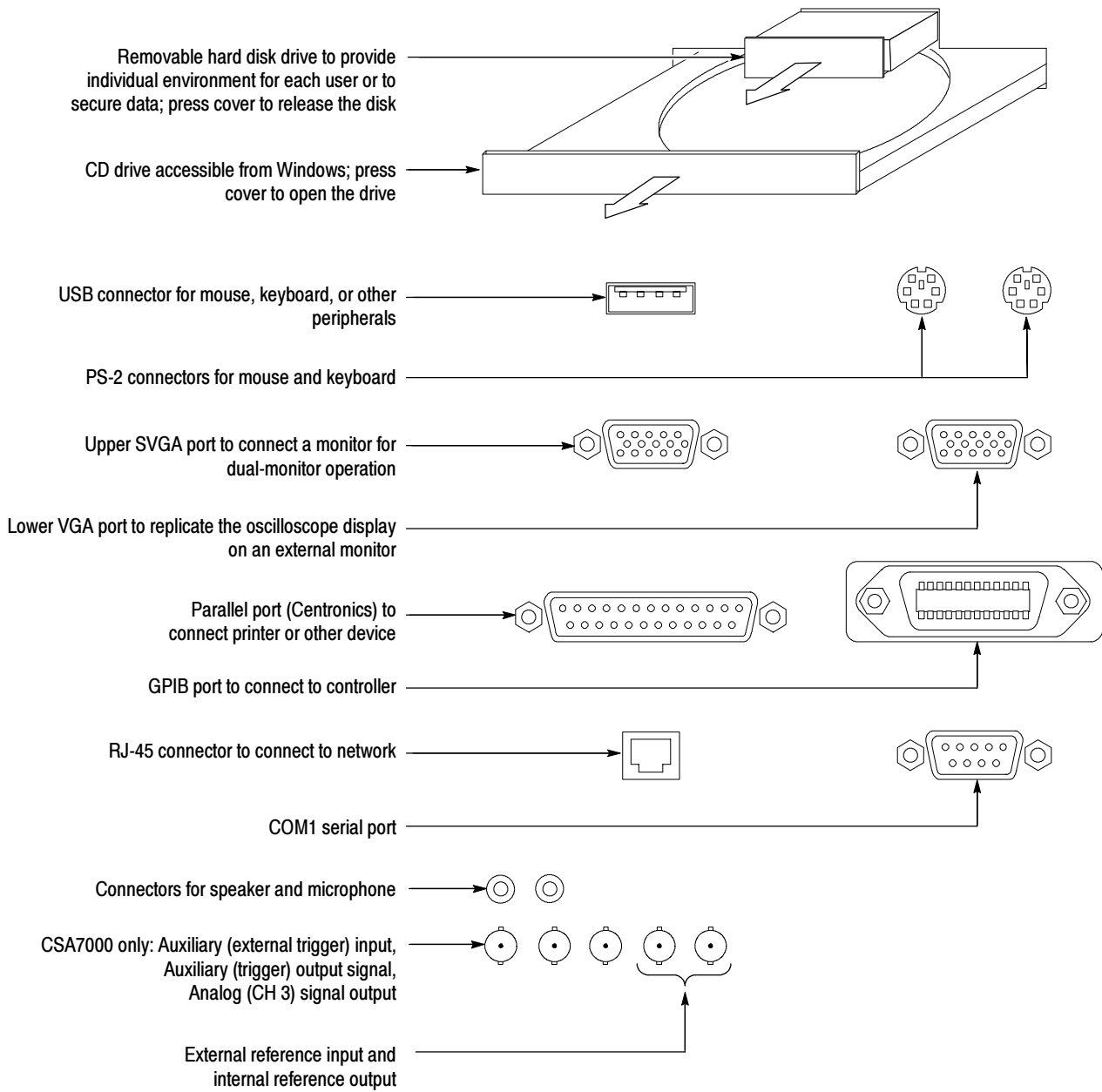

Recommended Probes and Accessories

**CSA7404, CSA7154
TDS7404, TDS7254, TDS7154**

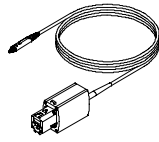

P7240 4 GHz Active Probe for general-purpose applications

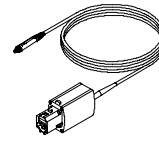

P7260 6 GHz 5x/25x Active Probe

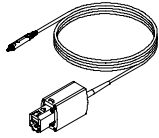

P7330 Differential Probe for differential-signal and low-noise applications

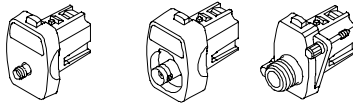

TCA-SMA, TCA-BNC 50 Ω , and TCA-N adapters for your probes and cables

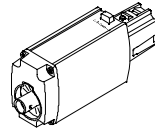

TCA-1MEG Buffer Amplifier to connect 1 M Ω accessories

TDS7104, TDS7054

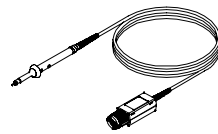

P6139A Passive Probes for general-purpose applications

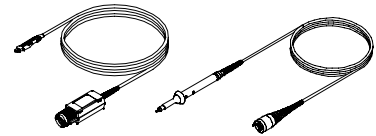

P6243 and P6245 Active Probes or P6158 Low-C Probe for high-speed applications

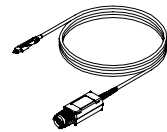

P6247 and P6248 Differential Probes for differential signals and low-noise applications

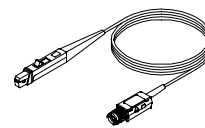

TCP202 Current Probe for general-purpose applications